

Research Paper

How anamorphic lenses influence cinematography

Comparing anamorphic and spherical optics and how they impact the viewer

Felix Laurin Stöger

Vienna Austria, 23/05/2023

Abstract

Cinematographers worldwide make creative and technical choices on how their movies are filmed. Anamorphic lenses are an important asset to many filmmakers. It is important to understand why these choices are made and how they affect the results.

This paper tries to shed some light on the topic of lens choice in the world of cinema production. Particularly the anamorphic lens concept will be discussed and dissected in detail. Why are these lenses so popular? How do filmmakers make use of them to capture the audience's attention? It is questions like these that this paper is going to explore and talk about in depth.

Extensive research and review of literature, articles, papers, and other sources have been conducted to gather information. Analysis of said sources helped to select what is relevant for each chapter.

Resulting from this research is a fascinating narrative on lenses, that helps the reader understand the thought process of a cinematographer.

The Anamorphic lens has a rich history in the world of filmmaking, the reasons why and how they are suited for a project can be as various as they are interesting, both from a technical and creative standpoint.

Table of Contents

Abstract	I
Table of Contents	II
1 Introduction	1
2 What is a cinema lens?	3
2.1 Anamorphic Lens Design	4
3 Cinema History and Origin of Cinemascope	7
4 Anamorphic Characteristics	10
4.1 How Creativity derives from Technology	17
4.2 Imperfection on Purpose	18
5 Cinema Production and Lens Choice	20
6 Conclusion	26
Bibliography	27
List of Figures	31

1 Introduction

With this paper I want to show the purpose and relevancy of anamorphic lenses in the film industry. When making a movie there are numerous things the cinematographer can do to change and influence the story visually. One of the biggest assets in this process is the lens that is used on the camera. It has the potential to immensely impact the final look and feel of a movie. Especially anamorphic lenses are appreciated for their unique look. What that means and why they are a beloved tool for many filmmakers will be analyzed.

The research questions for this paper are defined as follows:

- What is the difference between regular lenses and anamorphic lenses?
- How do anamorphic lenses work from a technical standpoint?
- Why were anamorphic lenses first created and how do they prevail to this day?
- How do different lenses influence how we perceive movies?
- Why do some people prefer to work with anamorphic lenses over spherical lenses and the other way around?

Personal motivation comes into play, as I am striving to improve as a cinematographer. Learning about the technical details and innovations of lenses and diving into other filmmakers' thought processes is something many people take an interest in once they enter this industry. Also, non-professionals can find a lot of interesting knowledge about how their perception of movies can be influenced by lenses.

The scientific motivation for this paper stems from the desire to understand how a tool for filmmaking can be used to impact the art and science behind filmmaking. The study of anamorphic lenses in cinematography can offer important insights into the visual language of film and how emotion, meaning and storytelling are communicated through it.

Thorough research of literature, papers and articles will be conducted, and the gained information will be utilized to give the reader valuable insights into the topic of cinema lenses. Additionally, interviews with industry professionals can provide valuable insights and perspectives from people who work with cinema lenses on a daily basis, allowing for a more in-depth analysis of the topic. The method of examining interviews in depth is particularly helpful for this paper as the subject is heavily dependent on practical use of these types of lenses.

1 Introduction

Cinematographers with decades of experience can provide in depth and interesting information about the topic.

First, I will establish what a cinema lens is, to give a better sense of all the technical details and differences to conventional lenses. Next, the reader will dive into the history of how cinemascope came to be and with it the anamorphic lens as a new innovation. Following that I will talk about what gives anamorphic lenses their unique look and how this creative tool is made possible through technology. Towards the end, I will give the reader a better understanding of how a modern film set works and give direct examples of how and why cinematographers choose their lenses to work with.

2 What is a cinema lens?

The term lens can be very vague. Eyeglasses or a magnifying glass for example, are both defined as simple lenses. When you take several simple lenses and through complex engineering put them together into a cylindrical shaped device, that fits onto a camera, it is called a compound lens. When talking about a compound or photographic lens, the single “simple lens” pieces are referred to as elements. They are designed to precisely refract the incoming light and form an image out of it. Furthermore, the position of each element can be manipulated mechanically to control the focal point. A physical iris, which is variable in size controls the amount of light that is allowed to pass through the lens (Holben & Probst, ASC, 2022).

The existence of cine lenses implies that regular lenses used in photography, have certain drawbacks, and are not suited for motion picture. So, what is the difference between a “normal” photographic lens and a cinema lens?

I will list the key differences starting with focus. In addition to the manual focus setting, most photo lenses have automatic focus, this is a feature you will never find in any lens built for cinema production. For moving images, the cinematographers want to maintain full control over the image, including focus. Their focus rings have a hard stop at the start and end of their range of motion. Clear markings either in metric or imperial form will precisely show the set focusing distance. This helps the focus puller as it enables him to match the focus distances to his hand unit. Because of that he always knows exactly what distance from the camera the focal plane is at. Most cine zoom lenses are parfocal. This means that once the focus plane is set to a certain distance, it will not change even while zooming. Because zooming is not a visible trait in photography there is no need to build photo lenses with a parfocal complication.

These lenses, while still being instruments of high precision, are built to last. Their durable bodies are machined from metal and can withstand harsh weather conditions. They need to maintain full functionality regardless of temperature. Cine lenses are also built in a way that no part of the lens will extend or retract while operating the lens. For photo zooms, you can often observe the length of the barrel changing with manipulation of the focal length. For filming this is not acceptable, since fluid heads, gimbals and other tools for operating cameras need to maintain balance throughout a shot and cannot afford this shift in weight. All these factors contribute to the generally higher weight and size in comparison to photo lenses, as these often use cheaper and less materials.

2 What is a cinema lens?

When it comes to light transmission, lenses use an aperture to stop a certain amount of light to pass through the lens. They are made up from numerous blades that are variable in their position to partially overlap. This creates a variable opening for light to pass through. Photo lenses are usually marked with F-stops to describe the different opening sizes. With cine lenses, T-stops are the norm as they do not describe the opening size but the actual amount of light being let through the whole lens. For example a T2.8 will be the same on every cine lens also set to T2.8, even accounting for different light transmission rates for glass in each lens (Holben & Probst, ASC, 2022).

2.1 Anamorphic Lens Design

Typical photographic lenses hold spherical lens elements which are rotationally symmetrical. These elements have an equal radius of curvature across their entire surface, resulting in an even distribution of light. Since the aim of anamorphic constructions is to compress the formed image in the horizontal plane, they need additional lens elements to achieve this. Cylindrical shaped lenses accomplish this, as they are a positive converging lens in the horizontal direction but will not converge the light rays in the vertical direction. The label “cylindrical” lens derives from its origin shape. The creation of a conceptual cylindrical lens can be described as slicing a geometric segment from a glass cylinder. The resulting shape appears curved like a convex spherical element, if looked at from the top. When we shift the perspective 90 degrees to a side view, the curvature disappears, and the lens looks like a flat rectangular piece of glass. Essentially the image is astigmatized by only affecting the focal point in one axis only. Even if in theory this is an optical error, for anamorphic photography this is precisely the wanted result (Holben & Probst, ASC, 2022).

Now we have established what causes the compression in an anamorphic image, but a cylindrical lens element by itself does not form an image. In order to form an anamorphic image, we have to combine a typical prime taking lens and an anamorphosing part either in front or behind that prime lens component. This anamorphic section of elements is called an anamorphot. In its most basic configuration, it contains two cylindrical components. These components themselves are made from two cylindrical elements that were cemented together. That leaves us with four elements in total being combined into two groups, forming the anamorphot. The combined or cemented elements are called doublets. The big advantage of using doublets over single elements or singlets, is that they prevent chromatic aberration from happening, by using two pieces of glass with a different refractive index (FindLight, n.d.). The anamorphot creates two different powers of magnification. One has a null effect, typically for the vertical axis and another one creates magnification, typically for the horizontal axis. When the spherical prime lens component is added to the anamorphot, it focuses the light rays into a formed complete image. When all of these groups are put together in a

2 What is a cinema lens?

single lens housing, it is called a monobloc design. When speaking of an anamorphic lens today, it usually always refers to a monobloc design, one singular lens attached to the camera with no further adapters.

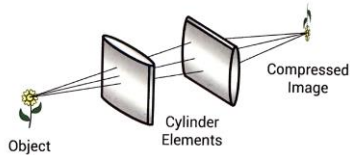
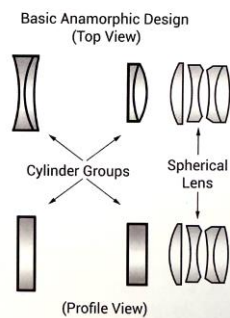

Figure 1. Top shows the basic concept of an anamorphot consisting of two cylindrical elements



Middle shows a basic anamorphic lens design consisting of doublet elements and a spherical lens behind it.

Bottom is the same lens, but in profile view.

(Holben & Probst, ASC, 2022)

Let us take a closer look at the differences between the front versus rear anamorphic lens design. Most anamorphics to this day are built in the front positioned configuration. This means that the anamorphosing group of elements is placed before the spherical group of elements. Because the compression of light rays on the horizontal axis occurs before hitting the entrance pupil of the spherical lens, the shape of this pupil is distorted to an oval. Physically the entrance pupil stays perfectly round but optically it appears elliptical because of distortion. This causes the bokeh of the image to be oval as well because the shape of the entrance pupil directly correlates with the bokeh shape. Furthermore, front mounted anamorphics are more likely to flare and exhibit stronger lens breathing while adjusting focus. All these characteristics are typically associated with anamorphic lenses and will be analyzed in detail in chapter four. When it comes to longer focal length lenses, most manufacturers switch their approach to rear positioned cylindrical elements. A longer focal length usually means a significant increase in size and weight. If the anamorphot was placed at the front, the weight would be distributed unevenly. Especially zoom lenses, which have highly complex mechanisms for zoom focus, are significantly more difficult to construct with a front positioned anamorphot group. When a lens manufacturer decides which of the two approaches suits their lens best, they have to consider placement carefully. An anamorphot placed behind the entrance pupil will leave it undistorted, meaning no change in shape of the bokeh. This is why placement of the anamorphic group is so important and has a major impact on the final look of the image (Holben & Probst, ASC, 2022).

Now we know how an anamorphic lens works in its most basic concept. A standard prime taking lens combined with an anamorphic group. For today's

2 What is a cinema lens?

application in shooting motion picture movies this is not sufficient. The image gets expanded through de-squeezing, but a certain amount of vertical stretching remains. This is particularly apparent when looking at actors on screen. They appear taller and skinnier than they are. To counter this, optical engineers came up with a solution that incorporates both compressing and expanding of the image at different stages during the light's path through the lens. One of the first to do this was the Norwegian optical designer Jan Jacobsen in 1958. He used two separate groups of cylindrical elements. The first one compressed the image on the horizontal axis and the second one expanded it vertically. Between the two groups, a spherical lens element was placed that would act as follows. When moving it towards one group the change in refracting power in one axis regarding that group, would be negated by the corresponding but reversed change while moving away from the second group that is oriented in the other axis. By doing this, the vertical warping of actors, also called the mumps distortions, were practically eliminated (Holben & Probst, ASC, 2022).

Let us take a look at a lens design that is used in a modern anamorphic lens, the Arri/Zeiss Master Anamorphics series. I chose this series because it is unique amidst other anamorphic designs as they are the only set of lenses not designed in two sections. Their cylindrical glass elements are not placed only at the front or back of the lens but are integrated and dispersed throughout the whole lens design. They are placed both in front and behind the iris. Essentially the Arri/Zeiss Master anamorphics are a complex merge of two separate prime lenses, with two different focal lengths, one double than the other prime. The two primes are put together into one optical system. The Master Anamorphics use a similar system as the design from Jacobsen, cylindrical compression, and expansion on different axis. They take this concept one step further by integrating double cylindrical lenses. These lens elements show a cylindrical shape on both the entrance and exit sides. They are able to achieve said compression and expansion within a single element. The biggest achievement of this system by Arri/Zeiss is the cylindrical cemented doublet that sits behind the iris. The connecting surfaces of the two elements are also cylindrical and the final furthest back surface is aspheric. This makes the lens contain an asphere at the beginning and end of the lens, making it exceptional at eliminating aberrations. With this exceptional approach, Arri/Zeiss created one of the highest performing lenses, showing off exceptional image quality (Holben & Probst, ASC, 2022).

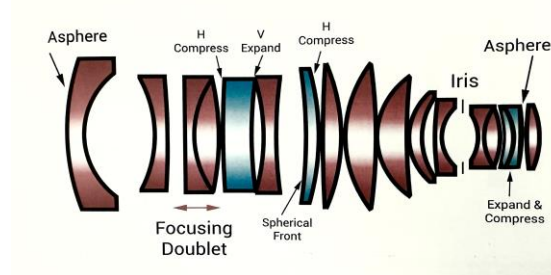

Figure 2. Arri/Zeiss Master Anamorphics lens design. This cross section shows the 50mm lens from this set. Cylindrical elements are colored blue and sphericals red. (Holben & Probst, ASC, 2022)

3 Cinema History and Origin of Cinemascope

The idea of using lenses consisting of cylindrical shapes to form anamorphic photographic images dates back to the nineteenth century. However at that time it was just that, a theoretical idea. Cylindrical lenses were so difficult and labor intensive to manufacture that it was considered to be impossible to make a practical system (Huntley, 1993).

In the year 1905, the French mathematician and astronomer Henri Chrétien already began creating some of the first anamorphic images with his own construction. In April of 1927, Henri Chrétien was attending the premiere of *Napoléon* by Abel Gance. For certain parts of the movie, the theatre used three projectors at the same time to fuse images into one big panoramic projection. Inspired by what he experienced, he wasted no time and started working on a new device capable of producing anamorphic images. This device needed to have the capability of having the produced images be corrected by a projection lens into a panoramic format on a screen (Google Arts & Culture, n.d). On April 29, 1927 the patent for this device was filed titled: “Procédé et dispositif pour la prise et pour la projection d’images photographiques ou cinématographiques panoramiques ou s’étendant en hauteur” (Method and device for capturing and projecting panoramic or height-extending photographic or cinematographic images) (No. 644,254; US patent No. 1,829,633). On June 9, 1927, the trademark “Hypergonar” was registered. The term derives from Greek (huper: beyond and gônia: angle) literally meaning beyond the angle. The construction of the hypergonar was only made possible by perfecting the industrial process of machining cylindrical high-precision surfaces. These processes had to be controllable to a fraction of a wavelength. Colonel Dévé ultimately created the machines capable of such precision. At first, this technology was used to build a periscope viewfinder for combat vehicles (Arnulf, 2003).

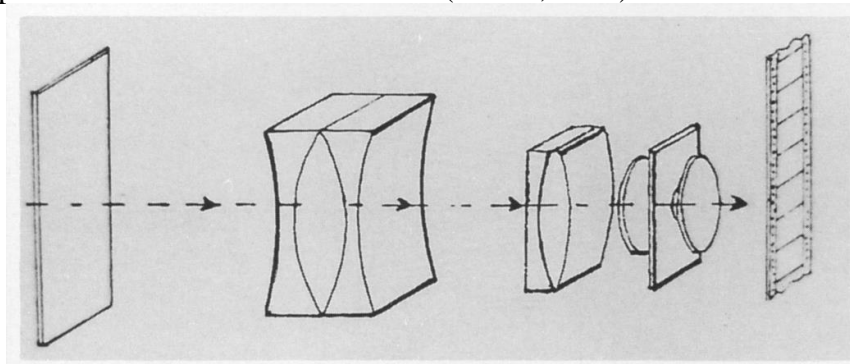

Figure 3. A sketch of Professor Henri Chrétien's optical system for the British patent of his original hypergonar lens (circa 1929). (Huntley, 1993).

3 Cinema History and Origin of Cinemascope

In November, 1927 the company STOP (Société Technique d'Optique et de Photographie) was established to manufacture the Hypergonar. The goal of this company was to launch the Hypergonar commercially. About a year later on October 15, 1928, Henri Chrétien and Henry Dain gave a presentation for the Board of Directors of Paramount, Adolph Zukor, Jesse Lasky, the company's technicians, and other guests. Lasky, who allegedly claimed, "I am enthusiastic about your invention", secured a one-year option on the Hypergonar. The same year major film companies started working on defining new film formats whose ratio was roughly 2:1. The goal was still to enlarge the cinema image, which has shrunken down almost to a square format due to the addition of the soundtrack on the film itself. Paramount developed its 56mm Magnafilm, Warners proposed the 65mm Vitascope and Fox presented its 70mm Grandeur film. In the end, Paramount preferred these new options compared to adopting Chrétien's cheap system and dropped the one-year contract with STOP they originally agreed to (Meusy, 2003).

At the 1937 Universal Exhibition at the Palace of Light, Professor Chrétien once more demonstrated his innovation. With a massive 600 m² concave screen set up outside, two twin projectors and Hypergonar technology were used to show the short film *Panoramas au fil de l'eau* (Panorama views above the water) by Jean Tedesco. A jagged overlay smoothed the transitions between the frames. This time, there were no vertical shots, but a third projector that was positioned in the middle enabled the projection of images in a normal format (Google Arts & Culture, n.d).

Television emerged as a new threat to film in the 1950s. Movie theatres were losing their audience. The CEO of Twentieth Century-Fox, Spyros Skouras, believed that technological advancement may assist to tackle the problem. Fox's research division was instructed to look for a new, reasonably priced projection technology. Chrétien's lenses came to mind and on January 29, 1953, a meeting between Chrétien, Skouras and other important figures of the Twentieth Century Fox company was held. There it was decided that this was the system Fox would go with, it was also the day that the name CinemaScope was chosen. Following that, Fox tasked Bausch & Lomb to produce Chrétien's design and with over 8000 lenses to be made by January 1954, placed the largest order of optical products in history to this date. After the debut of 'The Robe' at the Roxy Theatre in New York in September 1953, CinemaScope was very well perceived by the public.

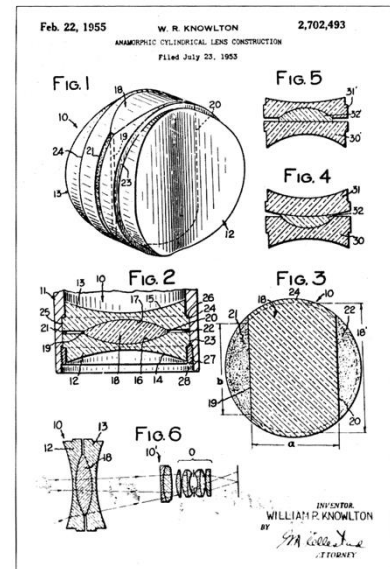

Figure 4. Bausch & Lomb patent application for a cylindrical anamorphic lens construction, based on Chrétien's design. (Holben & Probst, ASC, 2022)

3 Cinema History and Origin of Cinemascope

From then on it was the domineering film system in the early and mid fifties (Tietz, 2022)(Huntley, 1993).

A new competitor would step into the picture in the late fifties and early sixties, called Panavision. By working very closely with cinematographers Panavision created lenses that catered the needs of Industry professionals. This would mark the end of Twentieth Century Fox's CinemaScope lenses, just a couple of years after their rise. The founder of Panavision Robert Gottschalk, presented a new concept for projection technology where instead of cylindrical lenses two prisms were used to expand the image in the horizontal plane. The big advantage of this technique is that the prisms were put on pivots which could make them turn and change the magnification factor of the projection. This meant that you could set the projector to a non-magnifying x1 for standard 35mm film and back to x2 for CinemaScope screenings. Any other widescreen format in between was possible as well (Huntley, 1993)(Panavision, n.d.-b).

It did not take long for Panavision to also start looking into their own taking lenses. In 1958 Gottschalk presented his new product, the 35mm-format Auto Panatar camera lens, at a meeting of the American Society of Cinematographers. He drew direct comparisons to CinemaScope lenses, by showing images shot with both systems, highlighting Panavision's superiority when it comes to close-ups. Fox's system still struggled with strong distortion while Panavision managed to get rid of any noticeable warping of the image. The Auto Panatar quickly became the industry standard for anamorphic productions and even earned Panavision its first 'Scientific and Technical' Award from the Academy of Motion Picture Arts and Sciences (Huntley, 1993)(Panavision, n.d.-b).

4 Anamorphic Characteristics

One of the most prominent reasons for the popularity of anamorphics amongst filmmakers is their truly unique look. Every cinema lens has its own set of characteristics and even despite the fact that differences can be subtle for the untrained eye, they do play a big role in the final outcome and look of a movie. Because of their lack of technical knowledge, average moviegoers are unaware when a film was shot in anamorphic. But, if you ask them, they will tell you that they feel more connected and immersed in the film. The characteristics of anamorphic lenses play a big role in selling that immersion (Fauer, 2015).

Bokeh

The most notable and distinct characteristic is the bokeh. The term bokeh stems from the Japanese language (ボケ) meaning “blur” or “haze”(How to Create Bokeh - Bokeh Photography Tips | Nikon | Nikon, n.d.). It refers to the aesthetic quality of the out of focus area of an image. When parts of the background or foreground are outside a lens's depth of field, these out-of-focus areas result (BastianK, 2021)(Vorenkamp, 2016).

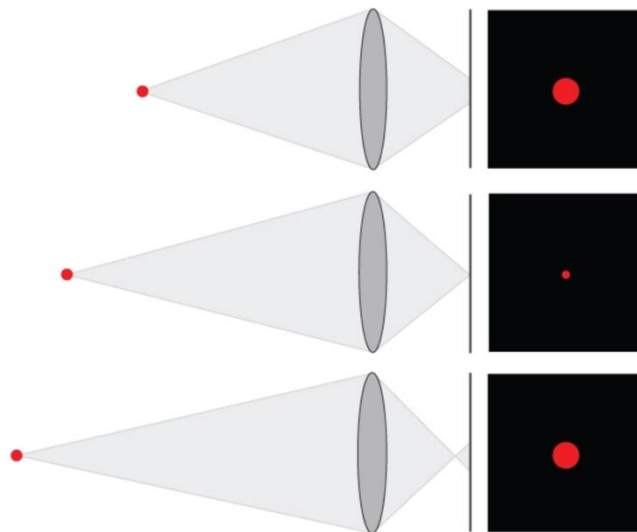

Figure 5. A point of light will appear as a circle on the image plane when said point is either in front or behind the focus plane. (Vorenkamp, 2016)

The design of the lens elements and the form factor of the aperture will influence the shape and characteristics of the bokeh. In the case of anamorphic lenses, the

4 Anamorphic Characteristics

most notable difference is the elliptical shape of out of focus light sources. For a spherical lens, these would appear rotationally symmetrical, and the image is considered stigmatic. The term "stigmatism" refers to the convergence of rays from an object point to a single image point. That means if an image is to be formed the rays of light must be bundled into one point. Each image point must have one object point. With anamorphics each object point that is out of focus results in two image points, making the image astigmatic. This occurs because in anamorphic lenses two sets of optics are used, one for the horizontal squeeze and the second one to focus an image onto the sensor (Fauer, 2015). The bokeh of a longer focal length appears larger on the image compared to a shorter focal length. The amount is equal to the magnification squared. This means that an 80mm lens has four times larger bokeh than a 40mm lens. Because anamorphic lenses squeeze the image, the out of focus area is affected accordingly to its magnification. A lens with a 2x squeeze factor, for example, compresses the image to half its width. At the same time, the out of focus area experiences the squeeze factor of 2x squared which results in a quarter of its width. When de-squeezing the image again its normal width is restored while the bokeh is still half as wide as it would normally be. It appears oval (Media Division, 2021).



Figure 6. Comparison between bokeh from a spherical lens(left) and an anamorphic lens(right). Pictures taken on a RED digital camera (RED, n.d.).

Blurry lights at night are not the only thing to consider when thinking about bokeh. The out of focus shapes in daylight and how they are presented on screen all add to the characteristic of a cinema lens. Optical vignetting influences how these shapes behave in an image. Virtually every lens has optical vignetting, and it becomes especially apparent when the aperture is wide open. It leads to a

4 Anamorphic Characteristics

reduction in size of the circular blur increasingly towards the edges of the frame. Because the depth of field is increasing together with optical vignetting it is said that most lenses experience less blur towards the edges and the most of it in the center of an image (BastianK, 2021).

Flares

Lens flares, also known as lens glare or light flares, are non-image producing light sources that disperse in the lens system after entering the lens through the front element. The glass surfaces within the lens reflect the light, eventually projecting it onto the sensor. Flare is a term that is very quickly attributed to shooting anamorphic. When people think of anamorphic lenses, they tend to think of the interesting flare this type of lens produces first (Sasaki Panavision, n.d.). Flaring is not exclusive to anamorphic lenses, but they are certainly enhancing the effect it has on the image (Maio, 2021). The reason for that are the anamorphic shaped glass elements in the lens which cause the flares to be either horizontally or vertically streaking across the image. Most anamorphic lenses have a very recognizable horizontal flare. Its color is dependent on the coating of the lens as well as the color of the entering light itself. The typical blue streak across the image, has become a staple in science fiction film productions. Because of the familiarity with the audience, this type of flare became a big part of pop culture. VFX Studios started emulating the lens flare not only in cinema but also in cartoons and video games (Sasaki Panavision, n.d.). Well known director J.J. Abrams even got criticized for excessive usage of the blue flare in his movies. (Acuna, 2015). It has to be said that the flare was not as popular as it is nowadays. For a very long time, cinematographers have done their best to hide these types of reflections. In 1941 Gregg Toland shot *Citizen Kane*. He wanted a look with a lot of deep focus, meaning subjects in the foreground and background are both acceptably sharp and in focus. To achieve this, he had to shoot with a small aperture opening, which resulted in having to use a lot of light with very high intensity to make up for the lost light of the small aperture. The amount of light would cause a lot of flaring which he countered by using "Vard Opticoat" non-glare coating. With that Toland set a new standard and from then on, lenses were constantly treated with new and better coating technologies. The new expectation for professional and immersive movies was for them to be flare free (American Cinematographer, 2017). In the 1960s cinematographers started to be dissatisfied with the clean studio look of their movies. They wanted to emphasize that their films are not shot on film stages, so they started to introduce flares again in similar ways as documentaries were showing them. Conrad Hall was the one who started this rebellious movement with the 1967 feature film "*Cool Hand Luke*". In the 1992 documentary *Visions of Light: The Art of Cinematography*, he said: „I feel particularly involved in helping make mistakes acceptable. If the light shone in the lens and flared the lens, that was considered a mistake.” From this point going forward the flare was used as a tool of realism or authenticity by some

4 Anamorphic Characteristics

cinematographers. In 1977 Steven Spielberg introduced flares to the science fiction and action world with “Close Encounters of the Third Kind” (Vox, 2016).

Besides the purely aesthetic use of flares, they can also be utilized in different ways. Some like to use it as a splash of color on darker spots of the canvas that is the image. It can also be used as a visual cue to signify that something is about to happen when light hits the scene (Sasaki, n.d.).

Compared to their anamorphic counterparts, spherical lenses have rotationally symmetrical flares, which in most cases are less pronounced and more subtle. Lens manufacturer Cooke is famous for its “Cooke Look” which prides itself in having subtle flaring even when shooting directly into practical light (Cooke, n.d.). Panavision on the other hand goes the complete opposite route with their anamorphic lens series. Especially their C series lenses have a very recognizable and unique flare. Their popularity among filmmakers is also hard to deny, considering this series was released in 1968 and over 220 titles were shot to this day (Shotonwhat, n.d.)(Panavision, n.d.-a).

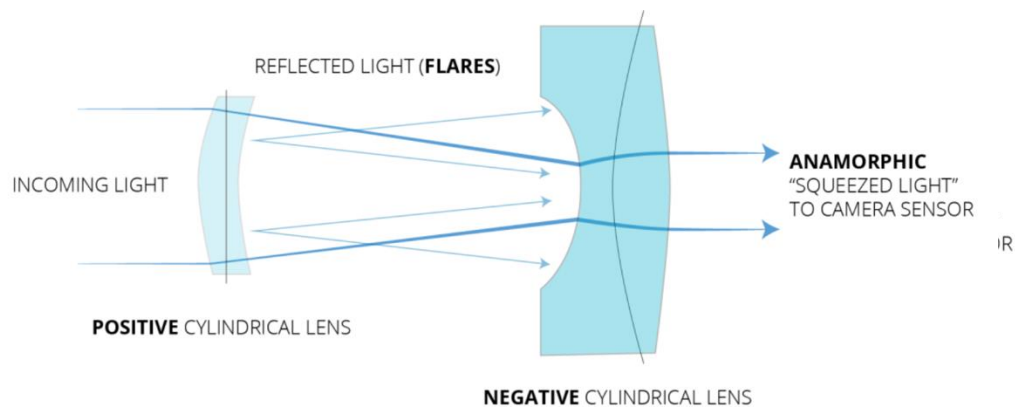

Figure 7. Light being reflected within the lens elements causing flaring (Anamorphic Store, 2017).

Arri has a different approach than most other manufacturers when it comes to flaring in their lenses. They came up with a system that gives cinematographers the freedom to work with different kinds of flares that vary in size, shape and color, without the need to change the whole lens set. The Master Anamorphic Flare Sets are designed for Arri’s Master Anamorphic lens series. Each set is comprised of easily replaceable front and rear glass elements, which are specially coated to give the desired look. Arri states that the optical performance of the lenses is retained, and greater creative value can be brought on set in a more economical manner (*Master Anamorphic Lenses | Lenses | ARRI*, n.d.) (Fauer, 2015).

4 Anamorphic Characteristics

Distortion

The anamorphic group of elements within a lens will enhance the distortions of the spherical block. That means that in most cases a spherical lens has less distortions than an anamorphic lens with the same field of view. There are exceptions to this rule. The so called barrel distortion is considered one of the key characteristics of anamorphic lenses (Media Division, 2021). It warps the image in a way that feels like the contents of the frame are pushed outwards towards the edges. The center of the image experiences the least amount of distortion while the edges of the frame are bending the light the most. This leads to the viewers eyes being guided to the center of the frame. It creates something that could be labeled as a ‘look here’ effect.

The opposite of the barrel distortion is called the pincushion distortion. Both types of image warping are caused by the shape of the lens and how they are manufactured (Adams, 2017). The design of the anamorphic block of the lens can cause the image to be stretched unevenly across the field of view. This can lead to over compression, especially at towards the edges of the frame (Media Division, 2021).

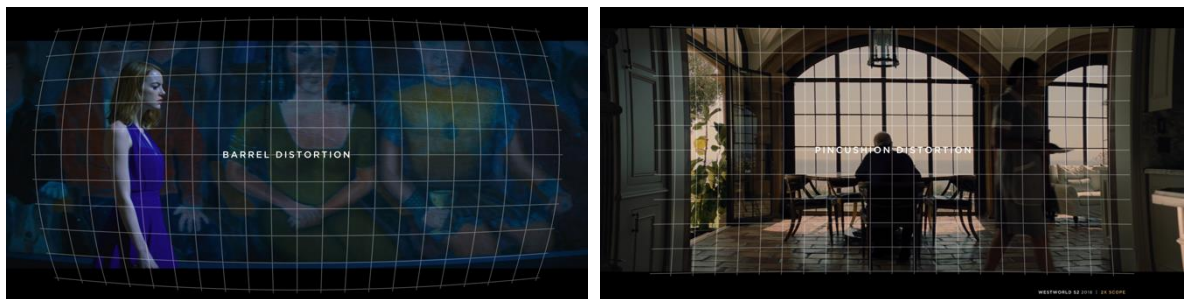

Figure 8. Barrel distortion(left) compared to pincushion distortion(right) (Media Division, 2021).

In its initial concepts Steven Soderbergh’s “No Sudden Move” did not show any intention of including any exaggerated image distortion. The movie was shot on a RED Monstro sensor and a set of Kowa Prominar lenses from the sixties. Because these lenses were not designed to be used with a sensor of this size the image would reach the very edge of the lenses field of view. This meant extreme distortion towards the edge of the frame. The initial framing was supposed to be cropped so the warping would not be too exaggerated, said Nat Jenck who is Steven Soderbergh’s long time colorist. When Steven saw what the lenses did to the image, especially when the camera pans around bending the image, he wanted to keep it. The cropping was reverted because of a conscious choice the Director-D.P. made with the characteristics of the Kowa anamorphic lenses in mind (Rentals, 2021).

4 Anamorphic Characteristics

Perspective & Magnification

In the previous chapter, we discussed optical distortions, there is another form of distortion that is not attributed to lens error. Perspective distortion is solely caused by the position of the camera relative to the subject that is photographed or recorded. Subjects very close to a wide angle lens, for example, may appear larger and disproportionate compared to objects in the background (Dhar, 2019). Anamorphic lenses have two sets of magnification for each axis. This means, in order to match the framing of a spherical and an anamorphic lens, the spherical has to have a shorter focal length or wider angle than the anamorphic one. Having a wide-angle lens up close to an actor's or actresses' face leads to unwanted distortions and unnatural face shapes. At the same time shooting in scope allows us to get up close and personal with the characters and still gives us a very good sense of their surroundings, while keeping the two things separated. When we are watching a movie, we subconsciously refrain from telling our brain that something does not look like it is supposed to in the real world, allowing us to follow the story a little bit more closely. With larger sensor sizes like full frame or medium format this effect gets even more visible. Perspective lines are less angled (Sasaki, n.d.).



Figure 9. Comparison between a primo anamorphic lens(top) and primo spherical lens(bottom). (Sasaki, n.d.)

Depth of Field

The gap between the closest and the furthest points that appear to be sharply focused in an image is referred to as the depth of field. The size of the camera sensor, the aperture, and the focusing distance of the lens all affect the depth of field. In addition, the sense of depth of field can be influenced by the viewing distance and image size (Team, 2021).

Technically anamorphic and spherical lenses have the same depth of field. Practically, there is a big difference between the two systems. For anamorphics to reach the same angle of view, their focal length has to be longer. This increase happens proportionally to the magnification or stretch factor of the lens. For

4 Anamorphic Characteristics

example, a 40mm spherical lens gives the same angle of view and subject magnification as an 80mm anamorphic with a factor of 2x. This can further be described as an anamorphic lens having two focal lengths at the same time. One for the horizontal axis and one for the vertical axis. All these factors give anamorphic lenses a perceivably shallower depth of field, which can help subjects to stand out from their background (Media Division, 2021) (RED, n.d.).

Asymmetrical Focus Breathing

Focus breathing, also referred to as lens breathing, can be described as the change in the angular field that occurs while focusing the camera's lens. General consensus is, that it is a rather undesirable feature for most lenses, as it gives an unpleasant visual impression during focusing (Tanaka, 2001). As the focusing distance to the subject changes, a lens's focal length changes subtly with it. Noticeability varies, as different lenses have different build qualities. Cine lenses are typically built to minimize focus breathing.

Anamorphic lenses behave differently from spherical lenses, in regard to lens breathing. Due to two different focal lengths in one anamorphic system, these types of lenses experience breathing in both the horizontal and vertical axis. Because the horizontal focal length is divided by the anamorphic magnification factor, the vertical focal length is the longer of the two. This results in a more visible contraction or extension of the image in the vertical axis while racking focus. As stated before, focus breathing is generally unwanted. Nonetheless, with anamorphic lenses, cinematographers found ways to use it as a tool to direct attention, because our eyes follow the subtle movement. Another possibility is evoking emotion that cues the audience that something is about to happen (Sasaki Panavision, n.d.). Although anamorphics have gotten more modern and advanced, they still show considerably more breathing than their spherical counterparts.

Widescreen & Aspect Ratio

To understand the role widescreen plays on the topic of anamorphic lenses, we must talk about aspect ratio first. Aspect ratio can be defined as the frame size that the cinematographer is recording his footage on. It is the proportion of the width and height of the image that is seen on screen (McCraine Justus, 2018). The formula for writing aspect ratios is width to height, like this: 4:3. A simple example is the ratio of 1:1, which equals a square because both the width and height are the same. Why do movies sometimes display black bars either at the top and bottom or to the left and right? Because aspect ratio was never standardized to be the same for all formats of filmmaking, screens cannot be built to fit all productions. Every cinematographer has the freedom to choose in which aspect ratio he or she wants to shoot the film at. Still, some ratios are very commonly used compared to others. 1.78:1, more commonly referred to as 16:9, is today's standard for HDTV. Engineers came up with this size because it is the

4 Anamorphic Characteristics

geometric mean between 2.35:1, which is the average ratio for most movies and 4:3, which was standard TV (Pogue, 2018).

As previously discussed in Chapter 3, a new kind of spectacle for the audience to combat low ticket sales was introduced in 1952. Cinerama was quickly replaced one year later by the anamorphic Cinemascope. This way only one camera was needed instead of three. The wide image was squeezed onto standard 35mm film, utilizing the whole space of the film. By re-expanding the image during projection, the widescreen aspect ratio of 2.35:1 was achieved (Pogue, 2018). Of course, it is possible to just use spherical lenses and crop the image at the top and bottom, but image information will be lost that way. Famous cinematographer Roger Deakins still prefers this method to anamorphic lenses because he does not like other characteristics of anamorphic (In Depth Cine, 2020).



Figure 10. Different aspect ratios used on the same still from Mad Max Fury Road (Studiobinder, 2020).

4.1 How Creativity derives from Technology

Creativity is the process of coming up with and putting into action meaningful and original outcomes regardless of area or subject. It can be found in all aspects of society, including the arts (writing, painting, photography, filmmaking, dance, music, and more); mathematics; engineering; the natural, social, and biological sciences; medicine; business; parenting; leadership; sports; teaching; and technology. Innovation is a process that can result from creativity (Kim, 2019).

The development, distribution, and marketing of goods are changing as a result of new technologies. These technological advancements provide new possibilities for the design, manufacture, delivery, and usage of well-known items in new and interesting ways, as well as for novel product combinations and completely new products. They also make fresh competition more likely (Miles & Green, 2008).

4 Anamorphic Characteristics

The cinema and television industries have been at the frontier of invention since more than a century ago when the very first motion picture was created. It's difficult to picture a time when watching a silent moving train on a cinema screen may have had viewers running for cover, but it only serves as further evidence of how the cinema has championed some of the most amazing visual arts innovations (MPA, n.d.).

Lenses are one of the most important assets in the cinematographer's toolkit. This holds true from the beginnings of cinema until now. The film industry has experienced technological advancements throughout history, making filmmaker's lives easier and giving them more choices for creative direction. Lens design improved a lot when modern computer hardware became affordable and optical design software was introduced in the 1970s (Neil, 2021). Lenses could be manufactured with greater precision allowing production to be tuned specifically for cinematographers. Greig Fraser for example, worked very closely with the manufacturer Arri, to design a new set of anamorphics for 'The Batman (2022)'. Him and director Matt Reeves, were drawn to the look of vintage anamorphic lenses, but were not satisfied with the overall image quality. Together with Arri they returned the Master Anamorphic series into the Arri Alfa anamorphics to give more corner falloff while preserving center sharpness. Only through decades of experience and technological advances, lens manufacturers like Arri are able to provide the tools filmmakers are demanding for their creative needs (*ALFA*, n.d.)(Greig Fraser, 2022). What used to be considered a mistake or lack of quality, was precisely reengineered in a way Reeves and Fraser wanted to.

4.2 Imperfection on Purpose

In order to talk about imperfection, we have to define what perfect in this context means. For something to be "perfect" it must be complete and correct in every way, of the best possible type or without fault (Cambridge Dictionary, 2023). Lenses are a tool to produce images, similar to our human eyes. The definition of a perfect lens can be described as the human eye itself or at least as the closest thing to it.

For most cinematographers, shooting in the anamorphic format means to embrace things that were once considered flaws. It forces us to think differently about how to capture images and what is considered beautiful or pleasing to the viewers eye. Optical perfection is rare to find in such lenses and they show a lot of visual imperfection compared to other types of lenses like primes for example. Lens manufacturers do their best to get rid of all these things like oval bokeh, flares, pincushion and barrel distortion and sharpness falloff in spherical lenses. For anamorphics this is exactly what makes them appealing to work with (Adams, 2017). Cinematographers often say that anamorphic lenses are tools to breathe

4 Anamorphic Characteristics

soul into the sterile digital world of filmmaking (Media Division, 2021). It is said that the bokeh of anamorphic lenses almost has a painterly quality to it. The softness resembles similarities to the strokes of a paintbrush (Anamorphic on a Budget, 2021). Just like certain styles of painting and art, the anamorphic lens embraces these qualities and makes use of the human nature to find appeal in imperfection. A style very similar to anamorphic bokeh is impressionism. With its rise in the nineteenth century, artists wanted to freeze transitional moments in time and have a lasting impression of light, very similar to the anamorphic characteristic. This form of art is defined by leaving visible brushstrokes. Certainly, a non-academic approach to painting at the time, but the impact and success of artists like Auguste Renoir and Claude Monet cannot be denied (Figs, 2019). They purposefully embraced the imperfections of their style, similar to what cinematographers do today with their lenses.

5 Cinema Production and Lens Choice

In this chapter, I want to give the reader a better sense of what it takes to produce and film a movie. This is important, if you want to understand how lens choice is a big component in the whole process of making a movie. Furthermore, I will give several examples from movies, TV Shows, and commercial projects where DPs and Directors have disclosed their lens choice. I will go into detail about the reasons for choosing anamorphic lenses over spherical ones and the other way around. I will talk about all the factors that come into play when making these choices, and how they affect the finished product and the viewer while watching a movie.

Every movie, before it is filmed starts in the development stage. This stage is about finding an idea, creating characters, and fleshing out a world where you want your idea to take place. A first synopsis is created as this is needed for the production team to sell the idea to potential investors and raise funds. It will often be accompanied by a first set of visuals, like storyboard images or stills that were shot with minimal crew. Even though shooting is still far away at this point, the early concepts of the movie will already have an influence on what lenses will suit the project later on.

The next stage will be financing and funding the project. Producers will meet with other producers, possible investors and financiers, a lot of times through people from their network. Often times they will travel to film festivals as they are a great opportunity to meet new investors and show them project material (Coutaud, 2019). The more funding can be gathered, the more crew, better locations and actors can be booked. With more funding, more and especially better equipment can be rented out, as gear for filmmaking is quite expensive. Anamorphic lenses especially often times have a higher cost per day compared to their spherical counterparts.

As soon as sufficient funds have been gathered and the spending budget is set, the next stage can commence. Pre-Production starts with casting actors, mostly referred to as talent on set. A crew is hired, locations are scouted, sets and props are built. The cinematographer together with the director compiles a shot list and producers start creating a timetable for the entire shoot, beginning broadly, and narrowing it down to a cohesive schedule as production picks up. On bigger, more professional sets the actors as well as the technical crew will have the time and resources to prepare efficiently for the production phase. For actors this means rehearsing and blocking scenes, while the crew will have lighting-tests and camera-tests. This is especially helpful for complicated setups and scenes, but is often skipped due to budgetary reasons or time constraints (Coutaud, 2019).

5 Cinema Production and Lens Choice

The next stage is the production itself, also referred to as principal photography. During this stage, all the needed footage and audio is recorded. The Crew comes together to create what was planned in the previous stages. Since there are a lot of people involved, working together efficiently and following protocols is an absolute necessity. If there is a hold up in one of the departments, it can cause the whole production to stop temporarily. That is why certain hierarchies exist on set and also within the separate departments. Let me break them down very briefly (Roberts, 2023).

The Director leads the whole production, he calls the shots and is tasked with guiding the actors to the desired performance. He communicates very closely with the other department heads to make sure his creative vision can be fulfilled. He or she is usually supported by a first and second assistant director. First AD is tasked with creating a daily shooting schedule as well as creating and sending out a call sheet to the cast and crew. He or she makes sure that everything is on track so that the director can focus on his work (Roberts, 2023).

Camera-Department: The cinematographer (Director of Photography) leads this department, he works closely with the director creatively to make sure his vision is portrayed the right way. The camera operator is in charge of controlling the camera during takes. He or she must be able to do fine or fast movements with great precision. On the other hand, operators need to be knowledgeable in the gear they are using, for example tripods, gimbals or hand wheels. A first and second assistant camera work underneath the operator or DoP, with their main tasks consisting of pulling focus (1stAC) and slating (2nd AC) (Roberts, 2023).

Lighting & Grip: As this is only a brief overview of the departments in filmmaking, I decided to put Lighting & Grip together. There is a lot of overlap in these two categories as they both handle similar equipment. The lighting department also referred to as “electrical” is run by the gaffer. His or her job is to plan out all the lighting setups with the cinematographer and coordinate his team to build them on set. The Grip department is coordinated by the key grip. His or her crew also handle a lot of the lighting gear and help to build special constructions for light and camera rigs. These departments are physically high demanding as they are first in and last out on the job generally, and they handle heavyweight equipment (Peerspace, 2022).

Art & Design: This department is comprised of the production designer, the art director, set dressers and prop masters. Together they craft the set and create the world the production plays in. Therefore, they contribute a great deal to the overall look and feel of the final product.

Wardrobe; Hair & Makeup: All those departments’ jobs revolve around styling and dressing the actors as needed. They need to bring a variety of skillsets to the table, as every production has different demands. From the casually dressed pedestrian to the exotic extraterrestrial being, making the characters look realistic and believable for the world they are set in, is their job.

5 Cinema Production and Lens Choice

After all the scenes have been shot, we move on to the next stage: Postproduction. Different to what the name implies, postproduction does not start at the end of the production phase. After the first day of shooting has been wrapped, all the footage from that day (better known as dailies) is delivered to the postproduction team. The post team can be broken down into four categories. Editing, Sound, VFX and Color. Editors assemble all the footage. Together with the director they assemble the selected takes from all the scenes into a rough cut. Their job is to craft a cohesive story and set the tone and pacing of the story through their cutting technique. The sound editor pieces together all required bits of audio, like dialogue, sound effects and ambient sound. Things do not always go according to plan on set, especially for sound recording. Sometimes lines go missing or are unusable due to other noises polluting the set. For the sound editor this means re-recording certain parts in ADR (automated dialogue replacement). Once everything is in place, the whole project gets mixed and mastered. VFX is short for visual effects. Especially nowadays with computers and software getting more powerful, this is an important step in the postproduction process. After the film has been put together into a usable cut, the visual effects team adds any additional VFX, such as CGI (computer generated images) or green screen. VFX is also often used to replicate an anamorphic look for projects filmed on spherical lenses, for example by adding horizontal flares. When shooting anamorphic, it is also common practice for the VFX team to record test charts and grids with the same lenses the movie was shot on. This is done in order to create distortion profiles for each lens so the effects added will match the distortion of the footage (Perry, 2022).



Figure 11. Lenses being checked on a Gecko-Cam Lens Projector in a large projection room. The prototypes looked contrasty, very sharp (high resolution), with very straight geometry. Same lens charts are being used by VFX teams (Fauer, 2015).

After all the editing and VFX is complete there is one final step necessary in postproduction, coloring. This is done by the colorist. His or her job is to give the movie its final look. At first, basic color correction is applied where necessary. This includes correcting over or underexposed images and adjusting the colors in a way that they resemble real life. After that, the corrected footage goes through

5 Cinema Production and Lens Choice

the color grading process. This enhances the colors that were chosen for the project, they set the mood and final look of the film (Roberts, 2023). Now that the cut, sound, VFX, and color are finalized, the initial idea in development, has been turned into a completed film that is ready for release.

The final steps in film production are getting the movie out there and having people watch and buy it. Distribution focuses on exactly that. They determine whether the movie will be released in theaters, video on demand platforms or both. The distribution team also handles availability for the domestic region and the chosen foreign regions. Marketing is focused on advertising the release of the movie and making people aware of its existence. This includes multiple media formats such as: online trailers, posters, billboards, and social media campaigns.

Now that we have established the basics of modern film production, I want to focus more on the principal photography phase. This is the stage where DPs and Directors come together and start creating their visual story. In today's day and age, cinematographers have a wide array of tools to choose from. Cameras, Lights and especially lenses. The choice of the lens is a particularly important one. A lens shapes the light that falls on to the sensor or filmstock. It can determine how close or far away we are to the subject or scene, how much foreground and background get compressed together, how much of the scene we can get in frame or focus. How much depth of field is shown? Is it possible to change focal length during a take? How close can we get with minimal focal distance? How does the Bokeh look? Image sharpness or softness, distortions, flaring. All these things have to be considered when choosing the lens. Different Productions have different wants and needs, but even within one shoot, the lens is changed for different scenes and sometimes even different takes within the same scene (Goldman, 2013).

I want to give a better insight on why certain lenses were chosen for specific projects and highlight the reasons behind these decisions.

Eric Edwards is a cinematography veteran with over fifty narrative projects completed in his career. He was hired by John Krasinski, who directs and acts in his new drama called *The Hollars*. During initial meetings between the two, they discussed aspect ratio. Edwards was used to shooting with Hawk 1.3x anamorphic lenses which usually result in a 2.35:1 aspect ratio. Krasinski felt that a 1.85:1 ratio would be more appropriate for the story he wanted to tell. Edwards proposed still using the 1.3x Hawks, but together with the ARRI ALEXA camera body, with the 4:3 sensor. The combination of lens and sensor size would result in Krasinski's preferred 1.85:1 aspect ratio while keeping the look of the hawk anamorphic lenses. This is a direct quote from the DP: "Native sensors have gotten so good and clean. Film always had artifacts, and tactile grain, and particular contrast and color characteristics. The lab and duplication process added more imperfections. We didn't think about these things until digital came along. I think the struggle for DPs today is to get back from the hyper-reality of

5 Cinema Production and Lens Choice

clean imagery, back to an artistic format that gives you a patina and puts a medium between you and the subject. It's about a cinematographer's choice of glass."

For Edwards the Hawks anamorphic glass gave him exactly what he wanted, a more textured look that helps him to pull the audience into the world he wants to portray (Vantage, 2015).

Linus Sandgren, ASC, FSF is an internationally successful cinematographer from Sweden. With titles like *Babylon* (2022), *La La Land* (2016) and *James Bond 007—No Time to Die* (2021) he has made his mark in the industry. When Sandgren is not working on feature film projects he also does high profile commercials in between. One of these projects was a spot for client Orangina, a French beverage company. It was directed by Matthijs van Heijningen and depicts a comedic battle between two gladiators in front of the Roman emperor. The spot was shot on an ARRI ALEXA XT, combined with Hawk 2x V-Lite anamorphic lenses. The reason behind this choice has to do with the setting of the spot. The Director and DP wanted to recreate the feeling of older films set in Roman times like *Spartacus* (1960) and *Ben-Hur* (1959), both shot for CinemaScope. The set was a 2000-year-old stadium in Croatia filled with hundreds of extras. In order to portray the world and its scale the right way, the 2x anamorphics proved to be the right tool for the job. Shooting on old school vintage spherical lenses and just cropping the image was considered but, ultimately the hawks gave them a more interesting look that fit the spot better. Furthermore, this highlights how all departments in filmmaking influence each other. In this case, set design and world setting played a major factor in the choice of the lens. He further states that when shooting digital, he will most likely choose anamorphics over spherical lenses because he considers the digital image too clean and boring. A direct quote from Sandgren: "You need to do something to create magic. Lens choice has huge importance when you are shooting digitally."(Vantage, 2015b).

A very different approach to the previous two projects could be seen on set for the feature film, *The Wolf of Wall Street* (2013), by Martin Scorsese. Together with cinematographer Rodrigo Prieto, ASC, AMC, he tells the story of infamous stockbroker Jordan Belfort's rise and fall. They wanted the audience to feel the differences in the stages of Belfort's career. The decision was made to distinctly differentiate the scenes visually, where the main character has clarity and direction in life, versus the scenes where he feels distressed and lost. Prieto opted for the use of spherical ARRI Master Primes and anamorphic Hawk V, V-Lite and V Plus lenses. For the first phase of the story, Belfort has not really settled into his new environment and feels some sense of insecurity. The use of anamorphic lenses with shallow depth of field and slight distortion emphasizes the soft look they were going for. Especially the slightly curved edges of the images helped to convey a sense of instability(Goldman, 2013).

5 Cinema Production and Lens Choice

For the second phase, when Belfort suddenly gains massive success, a spotless, cleaner, and sharper look was needed. They switched to ARRI's spherical master primes for a clear and sharp picture edge to edge.

The last phase treats the stockbroker's downfall and his world falling apart. For this section, Prieto created what he calls 'the paranoia look'. He returned to using Hawk anamorphic lenses, this time with longer focal lengths to induce the feeling of being spied on.



Figure #. Belfort under investigation. Prieto uses the anamorphic lens to create the "paranoia look" (Filmgrab, 2019).

This alternation between anamorphic and spherical glass on the same project is not seen very often, but shows how the use of different technological concepts, elevates the creativity of visual storytelling (Goldman, 2013).

6 Conclusion

The subject of anamorphic lenses can be very complex, but at the same time, it is a very useful and interesting topic to deal with. I gained a better understanding of the technical inner workings of a cine lens as well as valuable insights as to how anamorphic lenses can be used in ways one would not think of at first. Many people think of flares and bokeh only when hearing the word anamorphic, but there is much more to it. For example, cinematographers use them to draw attention or point out certain subjects in frame. The native widescreen format without the need to crop the frame, became a cinema standard thanks to the anamorphic workflow. It became clear that this technology has earned its place in the film industry and will continue to aid cinematographers in their visual storytelling.

During the process of research and writing this paper I gained a significant amount of knowledge that is helpful for my personal growth and interests and especially useful in my professional future. I have put together a conclusive and informative chapter about this technology's origin and history. It helps the reader understand why there was a need for this new kind of process. Furthermore, technical details and mechanisms of lenses are presented in a clear manner, breaking down all the major components of a cinema lens and highlighting the details how they differ from photographic lenses. Direct knowledge from filmmakers gives the reader a valuable insight into the process of choosing and working with a cinema lens, especially focused on the matter of: why anamorphic? Some filmmakers only use these lenses while others will refuse to work with anything else than a spherical lens. In some cases, the two different kinds get mixed even on the same set, to transport the perfect mood from the lens to the screen and into the minds of the audience.

Future research projects that build on this one, could consist of in-depth examinations of materials used to build lenses. In particular, the composition of glass and coatings used in different lenses, would be very interesting to take a closer look at. Furthermore, the psychological aspects behind lens choice and how filmmakers make use of these different tools to trick our minds, is another interesting take on the subject of lenses.

Bibliography

Huntley, S. (1993). Sponable's CinemaScope: An Intimate Chronology of the Invention of the CinemaScope Optical System. *Film History*, 5(3), 298–320.

Google Arts & Culture. (n.d.). *From Hypergonar to cinemascope*. (Media Division, 2021) [https://www.google.com/culturalinstitute/asset?id=cinemascope](#)

Tietz, T. (2022, September 16). *Anamorphic lenses and the birth of cinemascope Widescreen cinema*. SciHi Blog. <https://scihi.org/widescreen-cinemascope/>

Meusy, J.-J., & Williams, A. (2003). Henri Chrétien, Bernard Natan, and the Hypergonar. *Film History*, 15(1), 11–31. <http://www.jstor.org/stable/3815521>

Arnulf, A. (2003). Henri Chrétien (1879-1956). *Film History*, 15(1), 5–10. <http://www.jstor.org/stable/3815520>

Panavision (n.d.). History & Awards Retrieved March 20, 2023, from (Panavision, 2022) <https://www.panavision.com/about/history-awards>

Nikon Inc. (2015, April 30). *How to create Bokeh - Bokeh photography tips / Nikon | Nikon*.

Nikon | Shop & Explore Cameras, Lenses, and Accessories. <https://www.nikonusa.com/en/learn-and-explore/a/tips-and-techniques/bokeh-for-beginners.html>

BastianK. (2022, May 10). *Bokeh explained*. phillipreeve.net. <https://phillipreeve.net/blog/bokeh-explained/#Introduction>

Vorenkamp, T. (2016, January 18). *Understanding Bokeh*. B&H eXplora. <https://www.bhphotovideo.com/explora/photography/tips-and-solutions/understanding-bokeh>

Fauer Jon. (2015, May). *All About Anamorphic*. Film and Digital Times - Art, Technique & Tech in Motion Picture Production Film and Digital Times | The Journal of Art, Technique and Technology in Film, Video and Digital Production. <https://www.fdtimes.com/pdfs/articles/anamorphic/FDTimes-Anamorphic-Special-May2015.pdf>

Media Division. (2021, February 16). *SCOPE Chapter One – Anamorphic Lenses in Cinema with Theory & Poetry* [Video]. YouTube. <https://www.youtube.com/watch?v=blhaltLnSR0&t=1629s>

Maio Alyssa. (2021, June 28). *Lens flare — How to get it & avoid it*. StudioBinder. <https://www.studiobinder.com/blog/what-is-lens-flare/>

Adams. (2017, July 23). *Cooke anamorphic lenses bring class and character to a clean digital world*. ProVideo Coalition. <https://www.provideocoalition.com/cooke-anamorphic-lenses-bring-class-and-character-to-a-clean-digital-world/>

- Rentals, B. (2022, May 14). *Explaining the lens distortion in Soderbergh's no sudden move*. Bokeh Rentals. <https://bokehreferrals.com/6807-2/>
- Arri. (n.d.). *Master anamorphic lenses | Lenses | ARRI*. ARRI | Inspiring Images. Since 1917. <https://www.arri.com/en/camera-systems/cine-lenses/master-anamorphic-lenses/master-anamorphic-flare-sets-41902>
- RED. (n.d.). RED Digital Cinema | Professional Cameras. <https://www.red.com/red-101/anamorphic-lenses>
- Iain A. Neil. (2021, May). Evolution of zoom lens optical design technology and manufacture. *Optical Engineering*, 60(5). <https://www.spiedigitallibrary.org/journals/Optical-Engineering>
- Alfa. (n.d.). ARRI Rental Group. <https://www.arrirental.com/en/lenses/exclusive-lenses/alfa>
- Greig Fraser (2022, March 10). *The Cinematography of The Batman | Sound + Image Lab* [Video]. Interview by Glenn Kiser. Dolby Institute. <https://www.dolby.com/institute/podcast-series/>
- Tanaka, K. (2001, December 14). *Zoom lens without focus-breathing phenomena*. SPIE Digital Library. <https://www.spiedigitallibrary.org/conference-proceedings-of-spie/4487/0000/Zoom-lens-without-focus-breathing-phenomena/10.1117/12.450421.full?SSO=1>
- Aditya Aashish. (2022, November 22). *What is focus breathing in a camera lens?* PetaPixel. https://petapixel.com/focus-breathing/#What_Focus_Breathing_Is
- Dan Sasaki. (n.d.). *The Five Pillars of anamorphic – Disproportionate breathing*. Panavision. <https://www.panavision.com/highlights/highlights-detail/the-five-pillars-of-anamorphic-disproportionate-breathing>
- Acuna, K. (2015, November 23). *Director J.J. Abrams explains why there are so many lens flares in 'Star Trek'*. Business Insider. <https://www.businessinsider.com/why-star-trek-has-so-much-lens-flare-2015-11>
- Anamorphic on a Budget. (2021, January 25). *Why Anamorphics Boost Production Value - Anamorphic Cookbook - Module 1 Chapter 02* [Video]. YouTube. <https://www.youtube.com/watch?v=HVog0tn81I0>
- Cambridge Dictionary. (2023). <https://dictionary.cambridge.org/us/dictionary/english/perfect>
- Lydia Figs. (2019, August 22). *Unfinished: Why are we drawn to imperfection?* Art UK. <https://artuk.org/discover/stories/unfinished-why-are-we-drawn-to-imperfection>
- Arindam Dhar. (2019, October 25). *The truth about lenses and perspective*. Arindam Dhar – Creative Technologist / VR Enthusiast. <https://arindamdhar.com/lenses-and-perspective/>
- NFI Team. (2022, March 30). *Depth of Field - Everything you need to know - NFI*. NFI. <https://www.nfi.edu/depth-of-field/>

Cooke. (2023, March 23). *The Cooke look*. Cooke Optics. <https://cookeoptics.com/cooke-look/>

Shotonwhat. (n.d.). *Lenses Panavision C series anamorphic lenses*. ShotOnWhat? Movies & Television. <https://shotonwhat.com/lenses/panavision-c-series-anamorphic>

Panavision. (n.d.). *C series*. <https://www.panavision.com/camera-and-optics/optics/product-detail/c-c-series>

American Cinematographer. (2017, June 6). *Gregg Toland, ASC — An enduring legacy*. The American Society of Cinematographers (en-US). <https://theasc.com/articles/gregg-toland-asc-an-enduring-legacy>

Vox. (2016, March 28). *We've hit peak lens flare. Here's how it started*. YouTube. https://www.youtube.com/watch?v=_lesAvesFUo

McCranie Justus. (2018, November 16). *Aspect Ratios | Tomorrow's Filmmakers*. YouTube. <https://www.youtube.com/watch?v=BdPsyLtlamM>

Movie University. (2020, September 4). *Aspect ratios explained | How do aspect ratios work? | Why do some movies and shows have black bars*. YouTube. <https://www.youtube.com/watch?v=9-pPB75hH2Q>

Pogue, D. (2018, February 20). *A brief history of aspect ratios, Aka screen proportions*. Scientific American. <https://www.scientificamerican.com/article/a-brief-history-of-aspect-ratios-aka-screen-proportions/>

In Depth Cine. (2020, June 27). *The Difference Between Anamorphic And Spherical Lenses Explained*. YouTube. <https://www.youtube.com/watch?v=hzuFRgSUIyU&t=229s>

Miles, I., & Green, L. (2008). *Hidden innovation in the creative industries*. NESTA. https://e-space.mmu.ac.uk/624532/1/hidden_innovation_creative_industries_report.pdf

Kyung Hee Kim (2019) Demystifying Creativity: What Creativity Isn't and Is?, Roeser Review, 41:2, 119-128, DOI: [10.1080/02783193.2019.1585397](https://doi.org/10.1080/02783193.2019.1585397)

Coutaud, L. (2019, June 21). *Mastering the 7 stages of film production*. Student Resources. <https://www.nyfa.edu/student-resources/7-stages-film-production/>

Peerspace. (2022, February 8). *What is a grip in film?* <https://www.peerspace.com/resources/grip-film/>

Roberts, E. (2023, February 22). *The Stages of Film Production: From Script to Marketing*. Backstage. <https://www.backstage.com/magazine/article/film-production-stages-76000/#section2>

Perry, T. S. (2022, March 16). *How do VFX companies handle movies shot in anamorphic lenses where the image is squished before being stretched out with a look you can't...* Quora. <https://www.quora.com/How-do-VFX-companies-handle-movies-shot-in-anamorphic-lenses-where-the-image-is-squished-before-being-stretched-out-with-a-look-you-can-t-get-with-spherical-lenses>

Vantage. (2015, July). *Eric Edwards*. Vantage Film.
<https://www.vantagefilm.com/en/credits/testimonials/eric-edwards-10435>

Vantage. (2015, November). *Linus Sandgren, ASC, FSF*. Vantage Film.
<https://www.vantagefilm.com/en/credits/testimonials/linus-sandgren-10486>

Goldman, M. (2013, December). *Boom and bust: The Wolf of Wall Street*. The American Society of Cinematographers (en-US). <https://theasc.com/articles/boom-bust-the-wolf-of-wall-street>

Holben, J., & Probst, ASC, C. (2022). *The cine lens manual: The definitive filmmaker's guide to the design, implementation and history of motion picture optics*. Adakin Production Press Los Angeles, California.

Studiobinder. (2020, April 12). *The definitive guide to aspect ratios*. StudioBinder. <https://www.studiobinder.com/blog/aspect-ratio/>

Filmgrab. (2019, June 21). *The Wolf of Wall Street*. [FILMGRAB]. <https://filmgrab.com/2014/06/20/the-wolf-of-wall-street/#bwg1698/105899>

Anamorphic Store. (2017, January 9). *Anamorphic lens flares: How do they work and how to increase*. Anamorphic Lenses Store.
<https://www.anamorphicstore.com/anamorphic-lens-flare/>

FindLight. (n.d.). *Doublet cemented lenses*. Engineering marketplace connecting buyers with leading suppliers worldwide.
<https://www.findlight.net/optics/lenses/achromats/doublet-cemented-lenses>

List of Figures

Figure 1. Top shows the basic concept of an anamorphot consisting of two cylindrical elements.

Middle shows a basic anamorphic lens design consisting of doublet elements and a spherical lens behind it.

Bottom is the same lens, but in profile view.

Holben, J., & Probst, ASC, C. (2022). *The cine lens manual: The definitive filmmaker's guide to the design, implementation and history of motion picture optics*. Adakin Production Press Los Angeles, California.

Figure 2. Arri/Zeiss Master Anamorphics lens design. This cross section shows the 50mm lens from this set. Cylindrical elements are colored blue and sphericals red.

Holben, J., & Probst, ASC, C. (2022). *The cine lens manual: The definitive filmmaker's guide to the design, implementation and history of motion picture optics*. Adakin Production Press Los Angeles, California.

Figure 3. A sketch of Professor Henri Chrétien's optical system for the British patent of his original hypergonar lens (circa 1929).

Huntley, S. (1993). Sponable's CinemaScope: An Intimate Chronology of the Invention of the CinemaScope Optical System. *Film History*, 5(3), 298–320.

Figure 4. Bausch & Lomb's patent application for a cylindrical anamorphic lens construction, based on Chrétien's design.

Holben, J., & Probst, ASC, C. (2022). *The cine lens manual: The definitive filmmaker's guide to the design, implementation and history of motion picture optics*. Adakin Production Press Los Angeles, California.

Figure 5. A point of light will appear as a circle on the image plane when said point is either in front or behind the focus plane.

Vorenkamp, T. (2016, January 18). *Understanding Bokeh*. B&H eXplora. <https://www.bhphotovideo.com/explora/photography/tips-and-solutions/understanding-bokeh>

Figure 6. Comparison between bokeh from a spherical lens(left) and an anamorphic lens(right). Pictures taken on a RED digital camera.

RED. (n.d.). RED Digital Cinema | Professional Cameras. <https://www.red.com/red-101/anamorphic-lenses>

Figure 7. Light being reflected within the lens elements causing flaring. Anamorphic Store. (2017, January 9). *Anamorphic lens flares: How do they work and how to increase*. Anamorphic Lenses Store. <https://www.anamorphicstore.com/anamorphic-lens-flare/>

Figure 8. Barrel distortion(left) compared to pincushion distortion(right). Media Division. (2021, February 16). *SCOPE Chapter One – Anamorphic Lenses in Cinema with Theory & Poetry* [Video]. YouTube. <https://www.youtube.com/watch?v=blhaltLnSR0&t=1629s>

Figure 9. Comparison between a primo anamorphic lens(top) and primo spherical lens(bottom). Dan Sasaki. (n.d.). *The Five Pillars of anamorphic – Disproportionate breathing*. Panavision. <https://www.panavision.com/highlights/highlights-detail/the-five-pillars-of-anamorphic-disproportionate-breathing>

Figure 10. Different aspect ratios used on the same still from Mad Max Fury Road. Studiobinder. (2020, April 12). *The definitive guide to aspect ratios*. StudioBinder. <https://www.studiobinder.com/blog/aspect-ratio/>

Figure 11. Lenses being checked on a Gecko-Cam Lens Projector in a large projection room. The prototypes looked contrasty, very sharp (high resolution), with very straight geometry. Same lens charts are being used by VFX teams. Fauer Jon. (2015, May). *All About Anamorphic*. Film and Digital Times - Art, Technique & Tech in Motion Picture Production. Film and Digital Times | The Journal of Art, Technique and Technology in Film, Video and Digital Production. <https://www.fdtimes.com/pdfs/articles/anamorphic/FDTimes-Anamorphic-Special-May2015.pdf>